

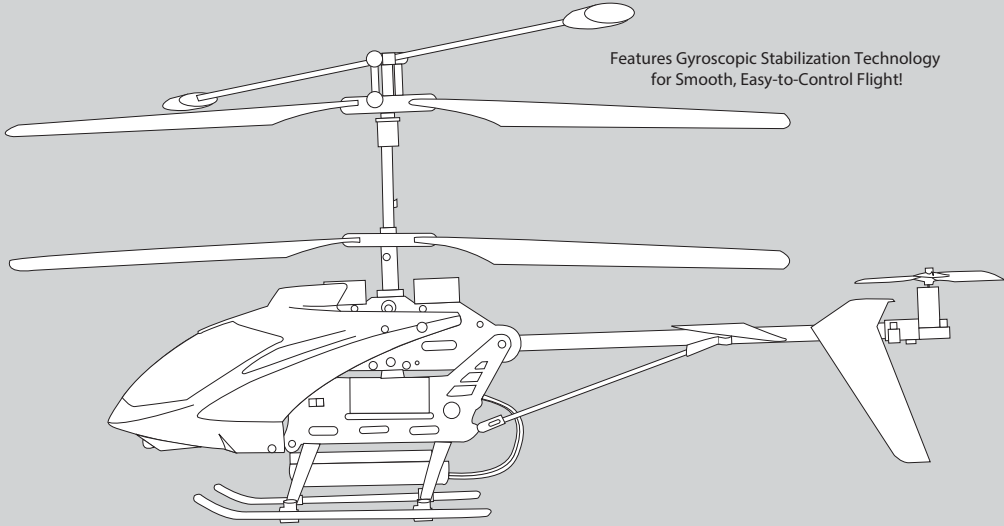

*Metal Body*  
*Indoor/Outdoor Remote Control Helicopter*



Features Gyroscopic Stabilization Technology  
for Smooth, Easy-to-Control Flight!

Distributed and serviced by: *Extreme RC by RSI...* Ferndale, MI 48220

Tel: 586-757-1336 E-mail: [Service@extremercbyrsi.com](mailto:Service@extremercbyrsi.com)

Website: [www.extremercbyrsi.com](http://www.extremercbyrsi.com)

*Open M-F 9-6 (EST) Sat 10-3 (EST)*

## MANUAL CONTENTS and PACKING LIST

### Manual contents

- Safety instructions
- Charging instructions
- Flying instructions
- Calibration trim control
- Inputting 'AA' batteries into R/C
- Changing R/C speeds fast to slow
- Changing helicopter battery pack
- Part list by number
- How to turn lights on and off
- How to set to low or high speed

### Packing list

- Extreme flying helicopter
- 2-speed remote controller
- Set of extra blades
- Extra tail blade
- A/C adapter power plug
- Screw driver
- 4-Landing gear cushions
- Manual instruction guide
- Warranty card

**Read the entire user's manual before operation.  
Save manual for future reference.**

# PACKAGE CONTENTS

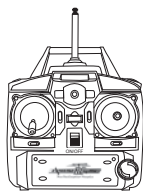

Remote Control

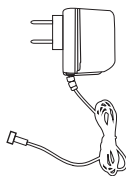

A/C Adapter

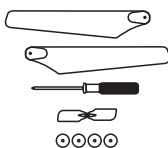

Extra Parts

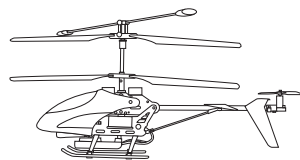

**XTREME™ S-6G** 3.5-Channel

## PREPARING THE REMOTE CONTROLLER FRESH ALKALINE BATTERIES STRONGLY RECOMMENDED

1. Install antenna by screwing clockwise in the top of remote controller (Diagram 1 below).
2. Remove the screw on the battery cover of the remote controller.
3. Remove the back cover of the remote controller and install (4) 'AA' batteries (not included) into the back of the remote (Diagram 2 below).
4. Replace battery cover and reinstall the screw.



Diagram 1

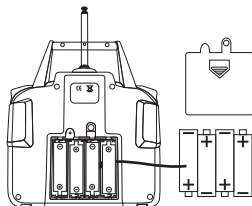

Diagram 2

### NOTE:

Please ensure the negative and positive terminals of the batteries are correctly installed.

Do not mix old and new batteries.

Please remove 'AA' batteries when not using remote control for 60+ days. Batteries may leak causing damage.

## CHANGING HELICOPTER BATTERY FOR LONGER FLIGHTS

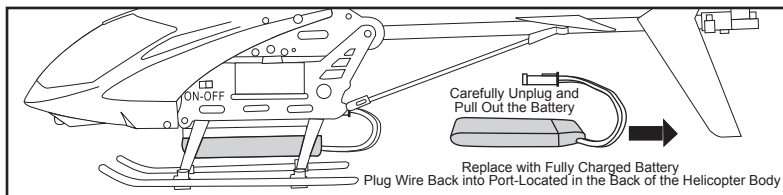

Carefully Unplug and Pull Out the Battery

Replace with Fully Charged Battery  
Plug Wire Back into Port-Located in the Back of the Helicopter Body

## CHARGING THE HELICOPTER

1. Be sure the helicopter power switch is in the OFF position.
2. Connect the cable end to the helicopter adapter. Plug the adapter into a power outlet.
3. Charge helicopter battery for 90 minutes, Flight time: Up to 10 minutes.
4. Unplug and put A/C charger away for safe keeping.

Charge Indicator Light

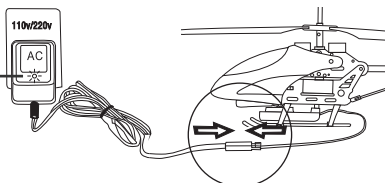

### CAUTION

Be careful not to over-charge the battery pack. This could lead to shorting the life of the battery.

Li-ion batteries could cause fire if there is misuse or if it is defective.

The LED light on the charging adapter will GLOW RED to identify that the battery is not fully charged  
The LED light on the charging adapter will GLOW GREEN to identify that the charging is complete.

**When the LED light GLOWS GREEN, your helicopter is ready for flight!**

## YOU ARE NOW READY TO FLY YOUR HELICOPTER

1. Turn on the power switch (ON/OFF located on the side of the body).
2. Place the helicopter on stable ground.
3. Extend the antenna on the remote controller and switch the controller to ON.
4. Stand back a minimum of 8' from helicopter.
5. To deactivate the safety on remote, pull the left throttle up - then down. The safety is now off and you can start flying.

## CAUTION

- Do not fly near homes, buildings, structures, water, vehicles, telephone or electrical wires.
- Keep flying helicopter away from pets, young children, the elderly and the disabled.
- Do not place stickers weights or anything else on the helicopter, this may cause the helicopter to crash or malfunction.
- To avoid injury, do not touch the blades or any other moving parts.

## ENVIRONMENT FOR FLIGHT

- Recommended flying area: 20'L x 20'W x 15'H indoors.
- Fly in good weather without strong wind, rain or snow.
- Suggest flying in an open area - without structures.

## REMOTE CONTROL FUNCTIONS

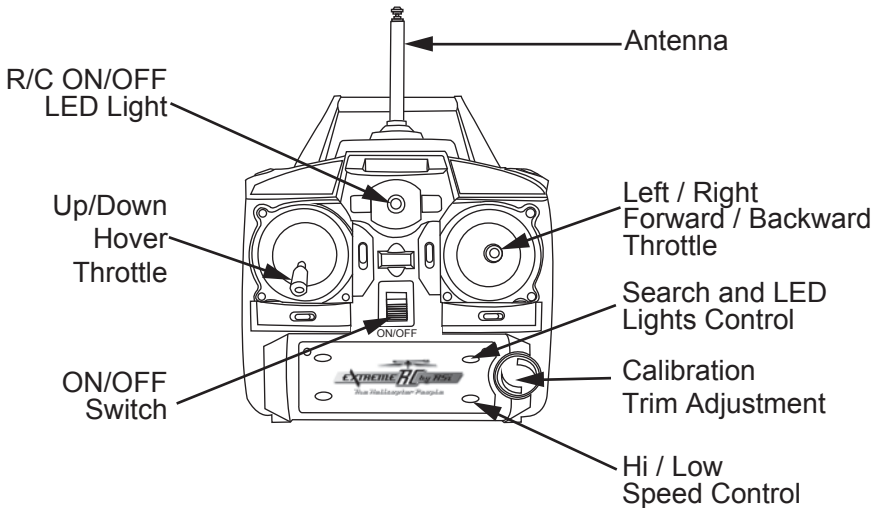

## CALIBRATION TRIM CONTROL

### Hovering ... Up/Down

Learn how to hover (fly in place) first – once you've mastered this operation, flying is easy.

Once you can hover, try moving up and down with the (left) throttle stick. Move the throttle stick gradually.

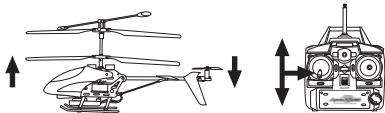

### Forward

Push the right control throttle stick up, the top of the helicopter will tilt downwards, the tail motor will activate, and the helicopter will fly forward.

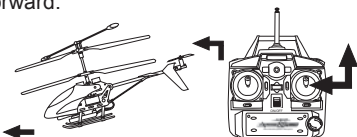

### Left / Right turns

While hovering helicopter, push (right) throttle stick left for counter-clock wise turns or right for clockwise turns.

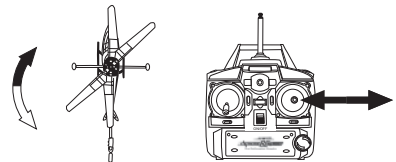

### Backward

Pull right control throttle down, the top of the helicopter will tilt upwards, the tail motor will activate, and the helicopter will fly backward.

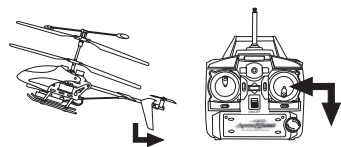

Note: Calibration trim control: If the helicopter is turning excessively to the right or left, or turning out of control, adjust the calibration trim control knob using the instructions below

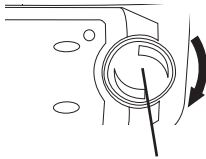
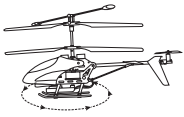

Turn trim control knob clockwise

If helicopter rotates counter-clockwise

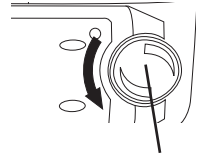
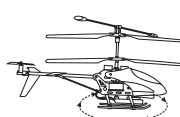

Turn trim control knob counter-clockwise

If helicopter rotates clockwise

## LIGHTS AND HI / LOW SPEED CONTROL

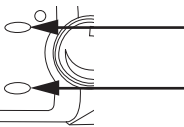

### Lights ON/OFF button

This will turn off helicopter LED night lights, saving battery power for longer flight time.

### Acceleration button

This is a two speed helicopter. Slow speed for beginners and fast speed for professionals.

## SPARE PARTS



#1 Head cover



#2 Main blades



#3 Tail and top fin with connectors

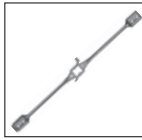

#4 Balance bar



#5 Balance bar connection set

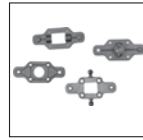

#6 Blade clip set



#7 Body support connect brackets



#8 Tail blade

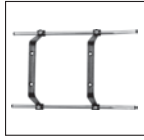

#9 Landing gear

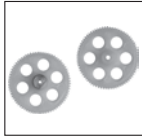

#10 Main gear set

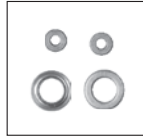

#11 Shaft bearings and gear bearings

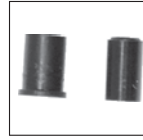

#12 Top shaft ball bearing housing

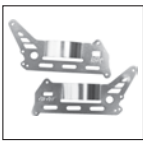

#13 Outer metal body

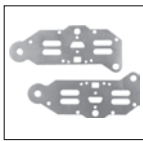

#14 Inner metal body



#15 Main rotor shaft



#16 Tail motor shaft



#17 Tail support bars

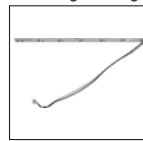

#18 Tail pipe with LED lights



#19 Center pipe



#20 Main motors set



#21 Tail motor



#22 PCP board with ON/OFF switch

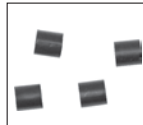

#23 Landing gear cushions set

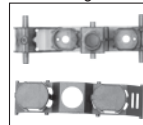

#24 Main motor housing set



#25 Li-Poly battery

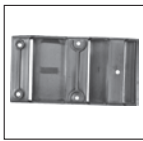

#26 Battery case housing

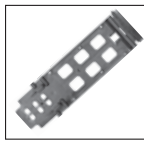

#27 Under carriage board

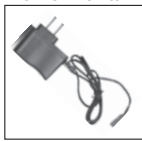

#28 A/C adapter



#29 Remote control

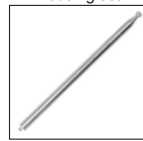

#30 Antenna

